

MEISER Rack grating

The perfect solution for your logistics



Shelf grating	4
Loose-fitting designs	4
Inserted designs	6
MEISER Modul	8
Load table and type overview	9
Advantages of the MEISER Modul	10
Possibilities to store euro pallets and half euro pallets	10
MEISER U-Channel Shelf Gratings	11
Product Specifications	11
The U-Channel	11
Grating Dimensions	12
Safety	13
Layout and Performance	13
Product Variations	14
Versions with heat sink sheet metal	15
Contact	16

MEISER Shelf Grating

MEISER shelf grating offers decisive advantages within logistics systems compared to other shelf coverings. In addition to their durability, they are above all permeable to light and water. This is a key feature when sprinkler systems are used. The high degree of transparency of the grating means that plenty of light is able to enter, thus providing high brightness levels in the logistics system; moreover, the items stored on the shelves can be identified from below.

Ingenious detailed solutions mean that the grating is easily installed and offers the additional integrated benefits. On the following pages we present our solutions, which have been developed together with the leading suppliers of logistics systems.

Loose-fitting designs

These versions of the MEISER shelf grating can be easily locked in place on the cross-members of the shelf structure. To this purpose, the T-shaped section surround, which is extended downwards, is provided with notches that are specifically adapted to the width of the cross-member.

The notches are punched up to the height of the bearing bars, so that the bearing bars are located flush on the cross-member and help to improve the statics. Further specific adjustments can be carried out, which are described below.

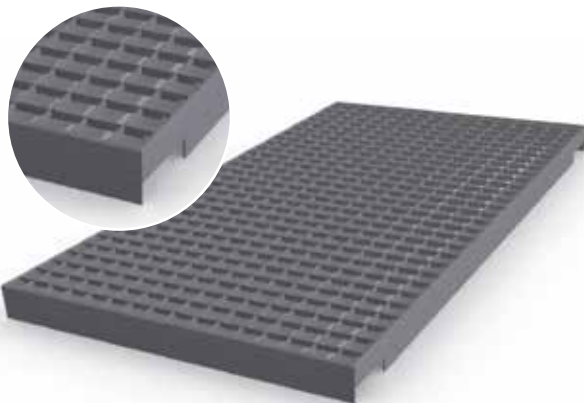

Shelf grating with notched T-shaped section banding bars

This is the standard design, which can be manufactured at low cost and which is suitable for various shelves of the same depth, but with different cross-members.

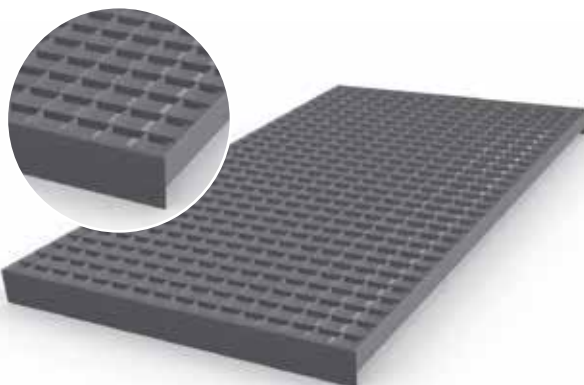

Shelf grating, bearing bar ends with deep T-Edging

This grating has a raised edge surround, albeit only at the ends of the bearing bars. The locking function is therefore less pronounced, but the possible applications are somewhat more flexible, as it is not necessary to use a specific cross-member width.

Shelf grating, notched with push-through protection

Push-through protection is an important safety element in shelf systems. If this has to be installed separately, it is associated with considerable costs.

MEISER has a shelf grating with integrated push-through protection in its range. The rear is edged with a reinforced flat bars, the height of which can be freely selected.

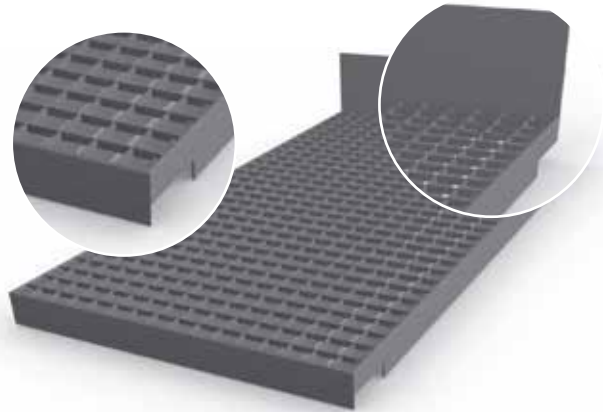

Shelf grating with additional notches in the area of the rests for double shelves

For so-called double shelves, MEISER has also developed a special type of grating. Additional notches allow a continuous connection across the double shelves. This grating can also be quickly installed.

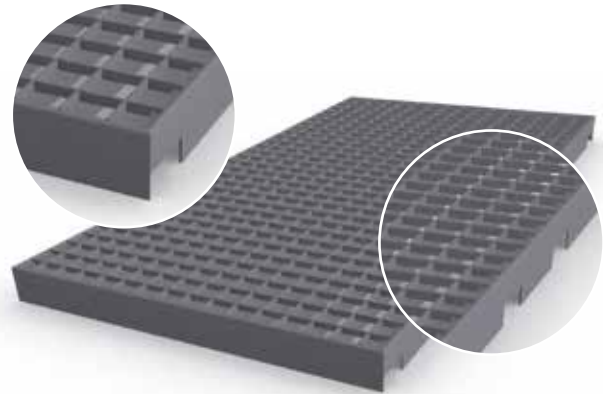

Inserted Designs

In addition to the loose-fitting versions, MEISER has also developed this solution. Here, the ends of the bearing bars are enclosed with a Z-shaped special section that is connected to the bearing bars by means of an automatic resistance welding process. This shelf grating is also very resilient as a result.

An important advantage of the inserted shelf grating is the improved effective height of the shelf spaces. Since this shelf grating is suspended between the longitudinal girders, the insertion height of a shelf is not reduced by the grating itself.

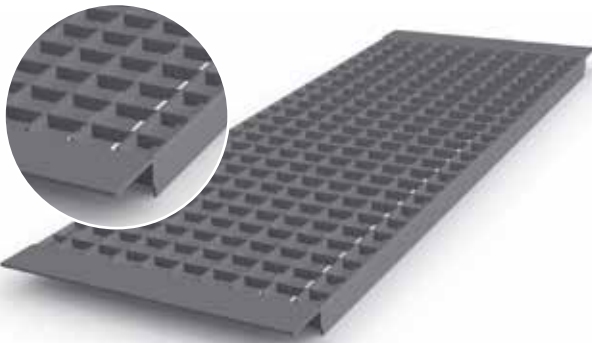

Shelf grating with Z-shaped angle section surround / MEISER special angle collar

This is the most common design of the inserted shelf grating. The angle collar used is a rolled section of our own design, which is inserted into the bearing bars and additionally welded.

For an order quantity of at least 500 pieces, this grating can be supplied with pregalvanized steel (S350GD) (for indoor use only) which is available at a considerably lower price.



Shelf gratings with Z-shaped angle section surround and push-through protection

The inserted shelf grating is also available with push-through protection. In this case the Z-shaped special section is supplemented by an additional section, which prevents the goods from being pushed through.

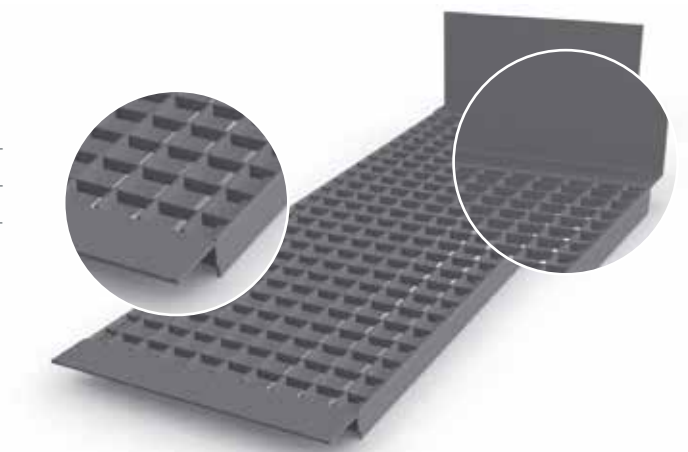

Shelf grating with U-shaped section surround

In this version, a rolled U-shaped section is welded to the ends of the bearing bars. The grating therefore lies within the shelves and is also locked with the cross-members by means of the U-shaped section. Additional safety will therefore be provided if the shelves are subjected to excessive loads.

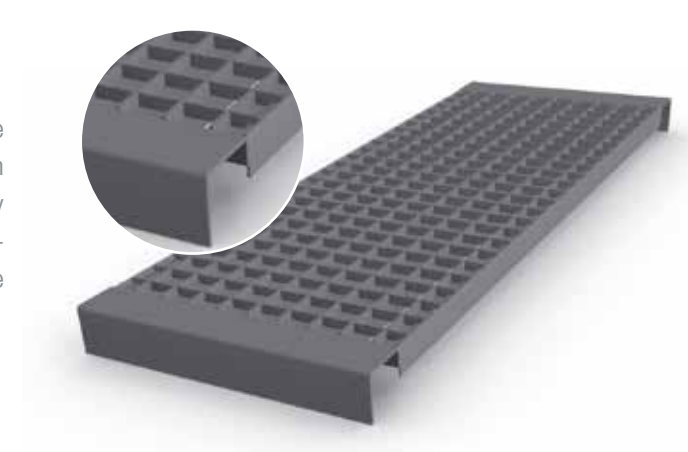

Grating for Double Shelves

This shelf grating element consists of two grating panels which are connected by a U-shaped section in the central area of the rests to form a unit. This creates a continuous connection across the double shelves, with the full shelf height being retained.

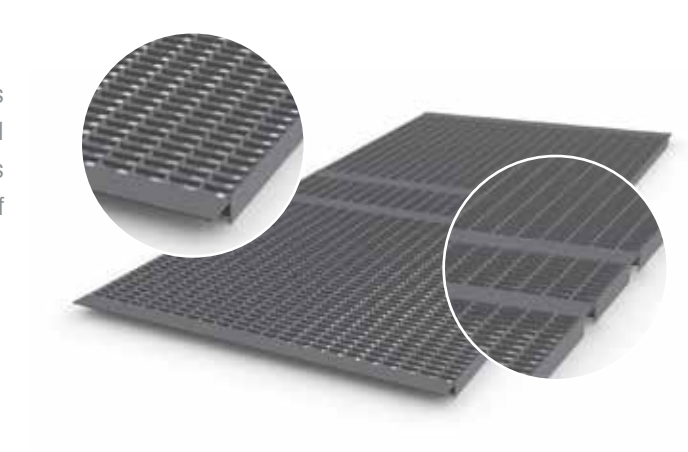

MEISER Modul – Strong. Light. Reliable.

Standard gratings are usually provided with bearing bars of equal size. Storage racks though are often loaded with load carriers which are hardly moved so that some bearing bars are never strained. Due to fix dimensions and the implementation of higher and consequently more resilient bearing bars at positions where a higher payload can be expected, and lower bearing bars at less strained positions, a very light shelf grating can be realized.

Precise loading conditions and allowed payloads are already known. The modules are optimally designed for the use of euro pallets or half euro pallets, placed lengthwise or crosswise, and different, evenly distributed payloads.

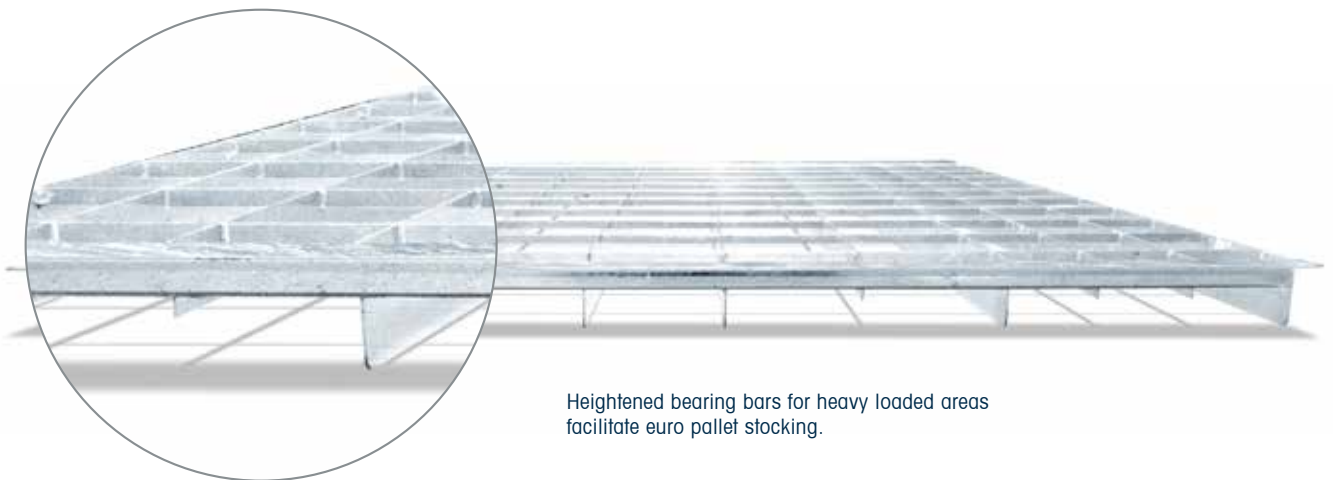
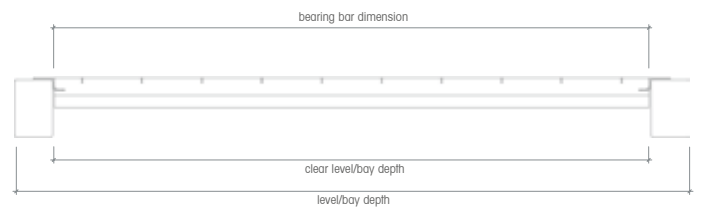
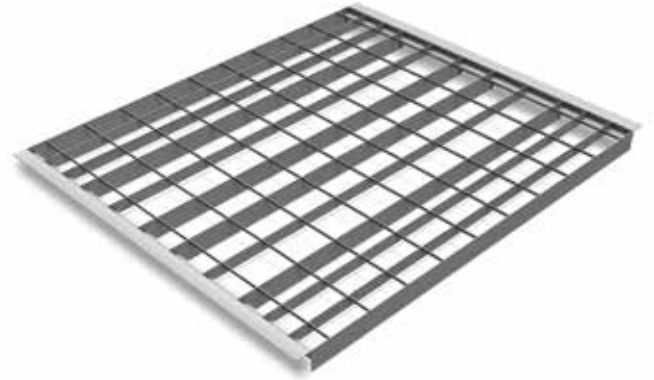

Heightened bearing bars for heavy loaded areas facilitate euro pallet stocking.

Load table and type overview

Payload (kg/grating)	Clear level/ bay depth (mm)	Width (mm)	Height (mm)	Material thickness (mm)	Mesh (mm)	
					BB	CB
1250	900 (895)	890	60	1,7	66(99)	66
	950 (945)	890	60	1,7		
	1000 (995)	890	60	1,7		
1000	900 (895)	890	60	1,5	66(99)	66
	950 (945)	890	60	1,5		
	1000 (995)	890	60	1,5		
800	900 (895)	890	55	1,5	66(99)	99
	950 (945)	890	55	1,5		
	1000 (995)	890	55	1,5		
500	900 (895)	890	50	1,5	66(99)	99
	950 (945)	890	50	1,5		
	1000 (995)	890	50	1,5		

MEISER produces 3 different grating types, each in 6 load categories. You will find the different types in the table, ordered downwards by maximum load.

The horizontal side of the Z-shaped profile is 40 mm for all grating types.

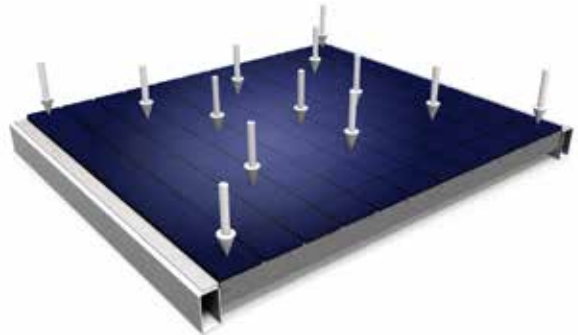

The composition of the MEISER module permits an evenly distributed payload.

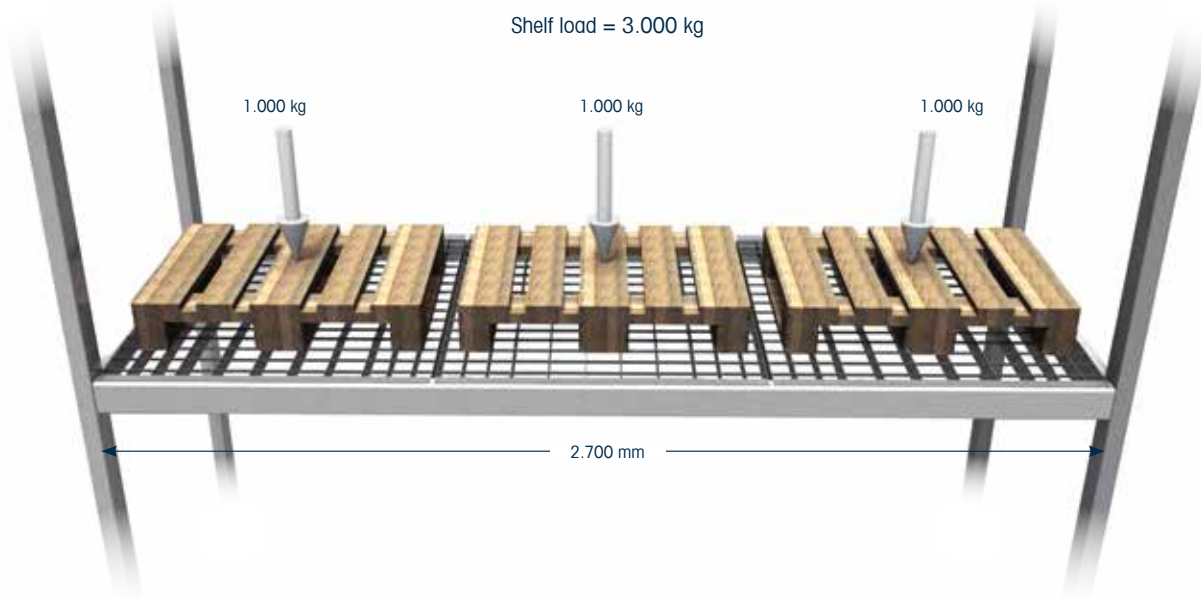

Application example of 3 MEISER Modul gratings, 995 x 890 mm, hot dip galvanized, with a max. payload of 1.000 kg each.

Advantages of the MEISER Modul

- provided with a Z-profile to insert the shelf grating (overlying installation height max. 2 mm)
- Simple choice of the load category (see table)
- Current dimensions for most shelves e. g. 1800 (2 parts), 2700 (3 parts), 3600 (4 parts)
- Fast delivery for stock products (small quantities on call order within 48h, large quantities on request)
- suitable for sprinkler systems (open cross section > 90%)
- little deflection under load (deflection < $L/200$)
=> in accordance to DIN EN15635
- low weight
- cost-efficient
- easily determine the maximum shelf load

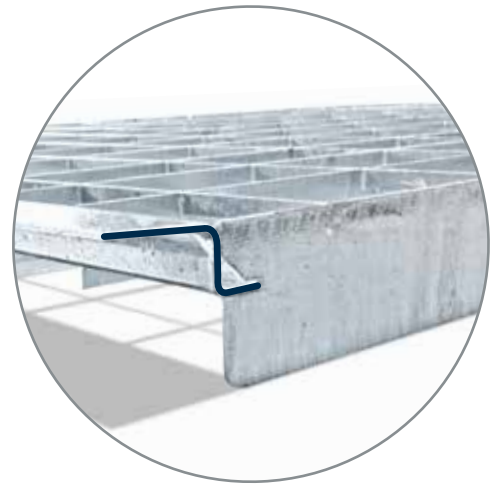

With the Z-Profile ist is possible to insert the shelf grating.

Possibilities to store euro pallets and half euro pallets

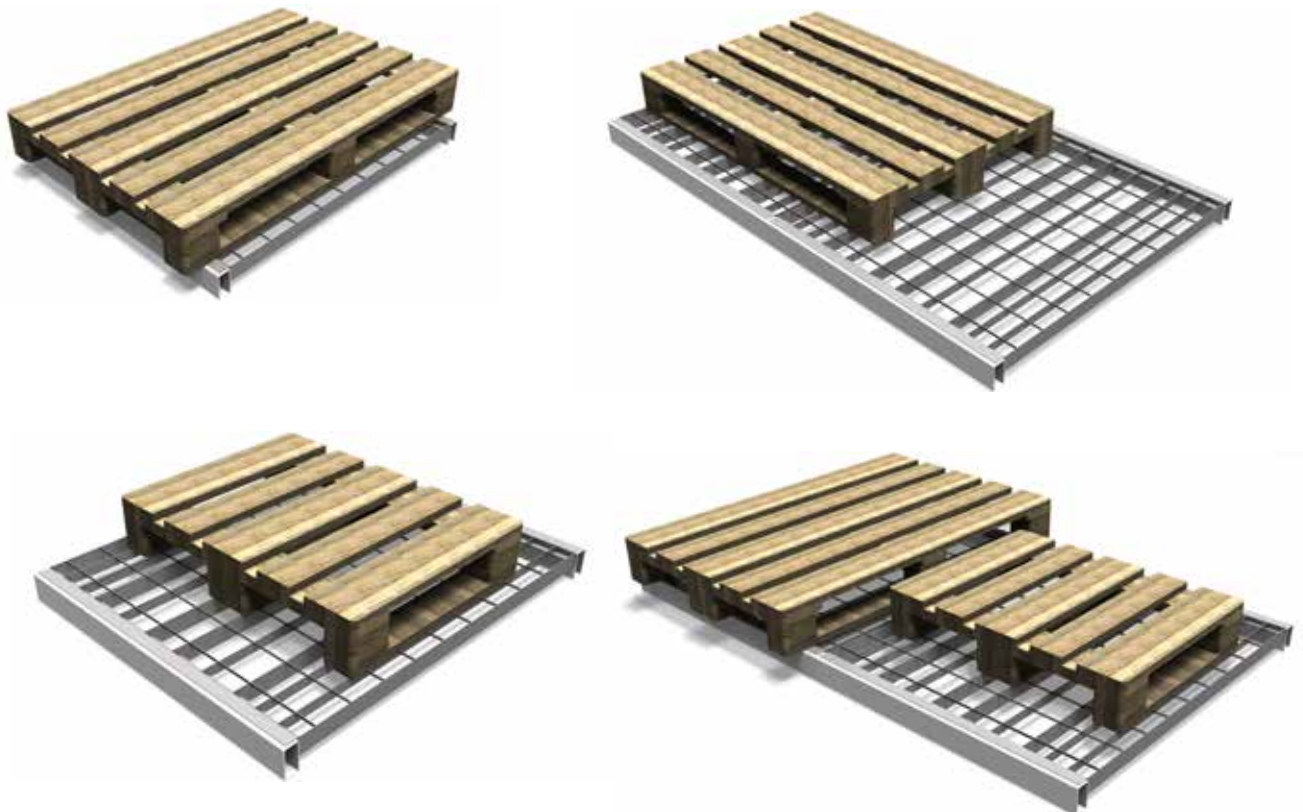

Product Specifications for U-Channel Shelf Grating

MEISER has always been at the forefront for reliability and progress. In our most recently developed product, the U-Channel grating, these two characteristics were impressively combined. MEISER has developed a grating which is capable of bearing up to 200* times its own weight.

This shelf grating was specifically developed for handling cardboard boxes. This patented design makes it possible to move these boxes on the deburred U-Channels without damaging them.

* Best theoretical ratio of distributed load in [kg / m²] to weight in [kg].

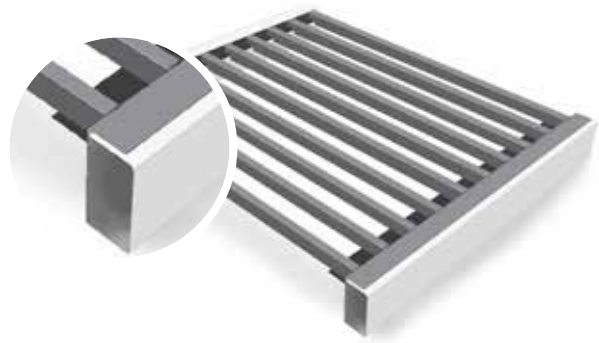

The U-Channel

Bending strength and safety are crucial criteria in the construction of shelving or racking systems. The U-Channel undoubtedly lives up to these demanding standards.

The example below shows the U-Channel 20x30x1.

Width w = 20 mm

Height h = 30 mm - 40 mm

Thickness t = 1 mm

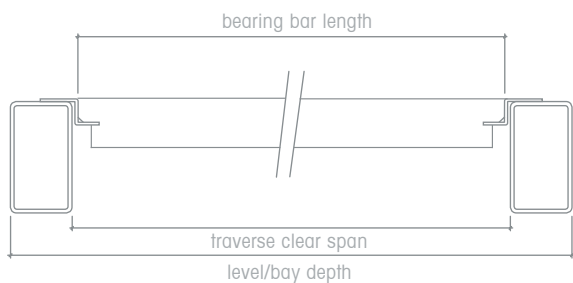
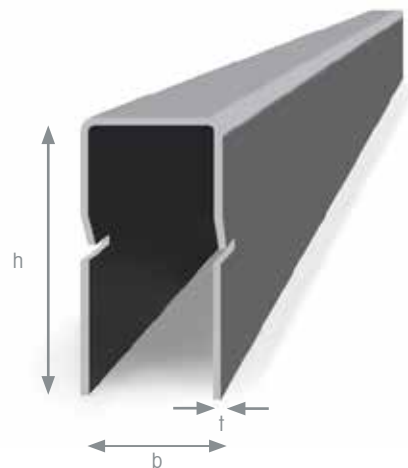

Inlaid shelf gratings

Inlaid product versions with z-profile are only offered with a pre-galvanized surface.

Grating Dimensions

The length of the grating also describes the length of the u-profile and corresponds to the (free) span of the shelf system. The U-channel shelf gratings are available in dimensions from 700 mm up to 1700 mm.

The width of the grating corresponds to the scheduled width of the shelf system, or portion thereof. This dimension indicates the pieces of U-profiles, which depends to the responsible partition of the bars. The most shelf systems will be manufactured in two or three parts. Shelf gratings are available with a width from 100 mm up to 1600 mm. However, the number of U-profiles is limited to 10 profiles per grating.

The partition of the profiles / bars is normally specified from axial dimension to axial dimension and is at least 70 mm. The „free span“ between each u-profile equals the axial dimension minus 20 mm. The span of each u-profile can be adjusted variable, so different axial dimensions within a grating can be realized. With bigger and smaller profile distances, the profile can support those areas where the load is the highest.

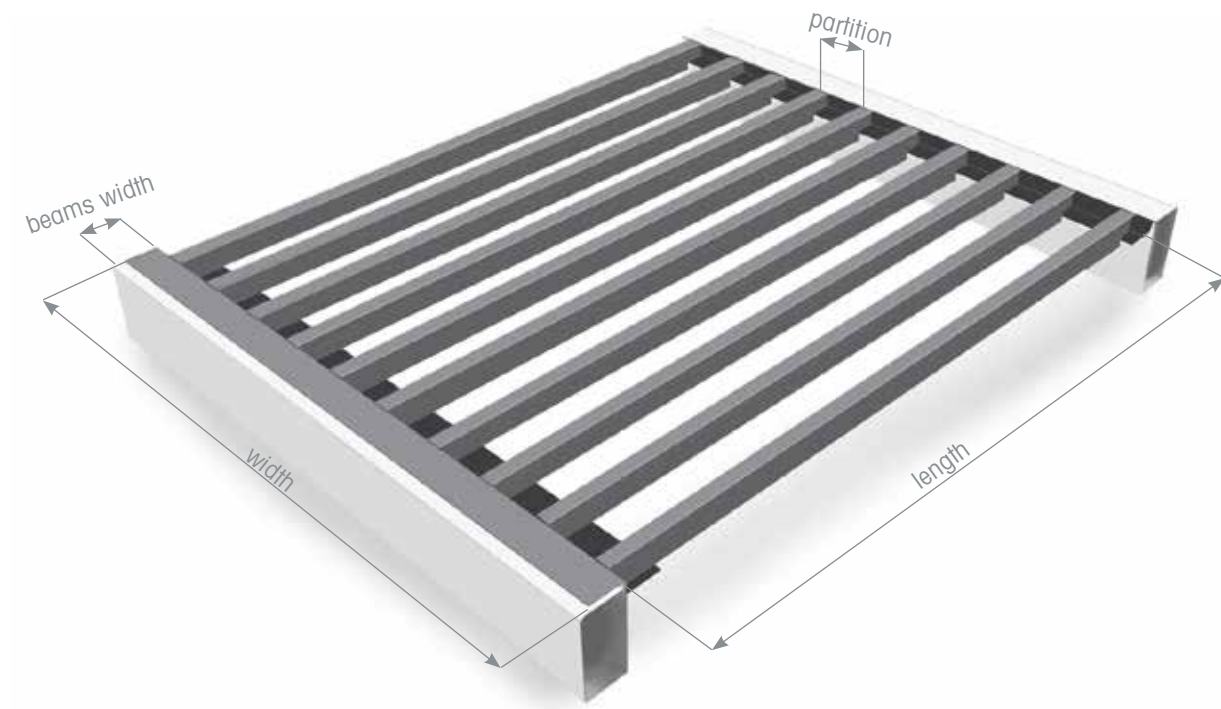

You have some special requirements to the MEISER U-channel shelf grating?
Contact us, we develop individual solutions for your shelf system.

Safety

If you choose to opt for a U-Channel shelf grating, you can be certain to receive a sophisticated product. Thanks to our own product development department there will be no weak

points. Prior to every order our structural engineers calculate the optimal structure of the grating and test it under real-life conditions to ensure its safe usage.

Layout and Performance

The new shelf grating not only looks good but also brings with it additional advantages:

- Open cross-section > 70%
- Perfect drainage for use in sprinkler-systems
- Ideal for handling loose cartons and boxes
- Variable dimensions possible
- Flat surface
- Low net weight
- High safety in case of accidental overload
- Simple installation
- Complies with requirements of DIN EN 15635

You need a shelf system that has to meet special requirements?

We develop tailor-made solutions based on your specifications.



Product Versions

In order to meet the requirements of our customers, we have developed different versions of the U-Channel grating.

Standard-Version

This grating was specifically developed to store cardboard boxes with loads up to 1000 kg UDL. The loose-fitting version always has an upbulding height of 20 mm. The inserted version builds up max. 2mm on the beams.



inlaid
(pregalvanized)

Grid-Version

This grid is particularly suitable for the storage of small packages and cardboard boxes with a low weight and is only available in the inlaid version. It builds up max. 2mm on the shelf beam.



inlaid
(hot dip galvanized)

Pallet-Version

This grating has been optimized for the support of Euro pallets and is only available in the inlaid version. It guarantees safe storage up to 1000 kg per pallet.

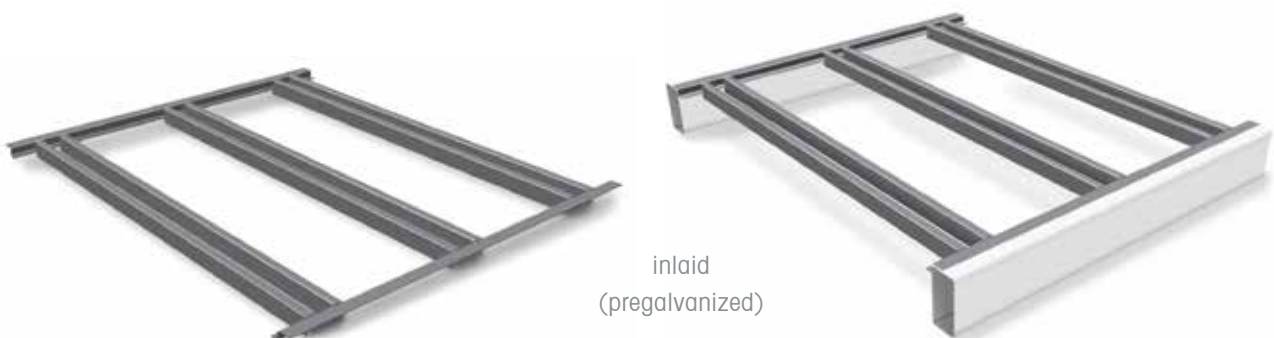

inlaid
(pregalvanized)

Versions with heat sink sheet metal

This grating was specifically developed for the fire protection requirements required by law. A 0.8 mm thick and pregalvanized smooth sheet metal is applied to the U-channels or, in the case of gratings, on the Z-profiles and thus functions as a heat sink.

U-Channel-Version

(pregalvanized)

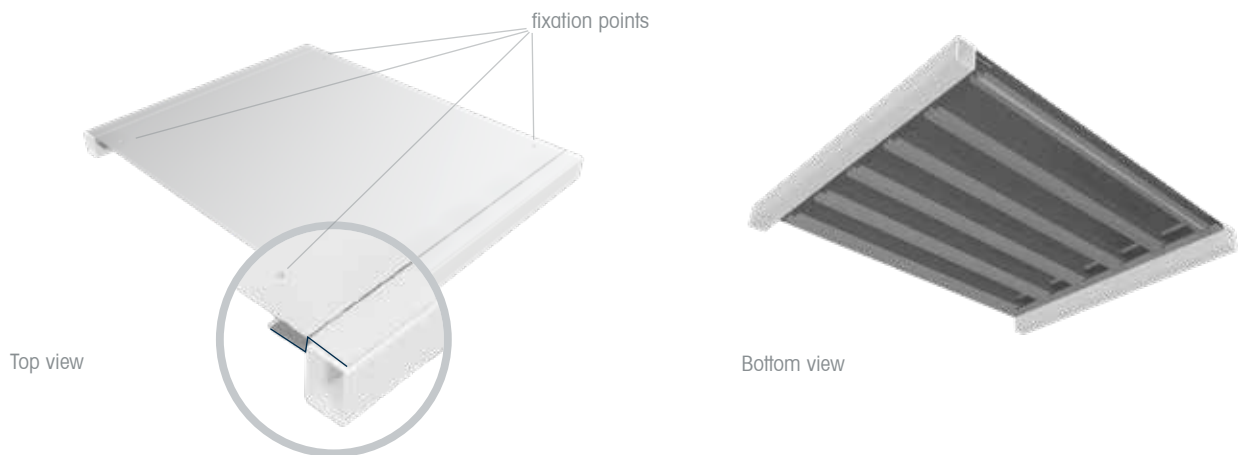

Grating-Version

(hot dip galvanized or pregalvanized)

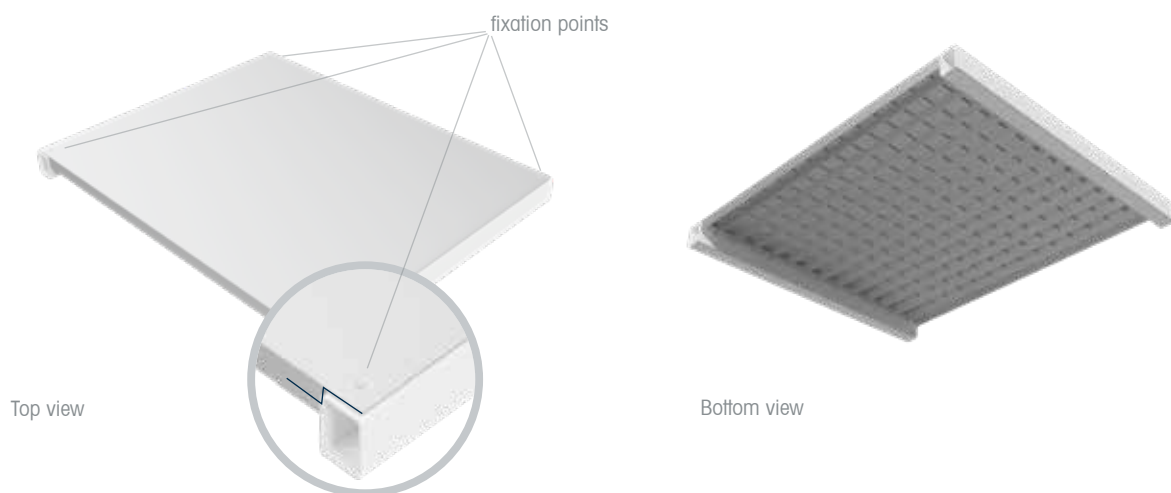

Please don't hesitate to contact us with your enquiries or requests.
We are pleased to help you!

Sales



Jerry Hägglund

Telefon: +46 (0) 10 458 00 00

E-Mail: j.hagglund@meiser.se



Jessica Persson

Telefon: +46 (0) 10 458 00 00

E-Mail: j.persson@meiser.se

Our international manufacturing bases, establishments and representations can be found at www.meiser.de

MEISER Sweden AB

Flygfältsgatan 16 a

423 37 Torshälla

Tel +46 10 458 00 00

E-Mail info@meiser.se

www.meiser.se